



Brief Company Overview



Our Story

- **History**

- Founded in 1998 as an Application Lifecycle Management software company
- Now - Full lifecycle solutions development and delivery, CA and IBM i/z
- Referenceable enterprise customers
 - Banking industry: Deka Bank, Olympia System, ...
 - Government: Switzerland Ministry of Justice, Social Security Administration, Texas A&M, State of Illinois ...
 - Hapimag, Praktiker, North American Stainless, Columbus Steel, ...
- Privately held, 30 employees / consultants before recent expansion

Company Profile

- **Swiss Headquarters**
 - Focus on Quality and Reliability
- **International Presence**
 - Milan, Austin, World wide resellers
- **CA Primary Reseller**
 - Euro Zone, North America
- **Quality Proven Products**
 - WebClient i+ (and PHP, Websyidian)
 - Matchpoint ALM, MKS Connector
 - Soreco Xpert Ivy for BPM
 - Daborough X-Analysis
 - Worksoft Certify

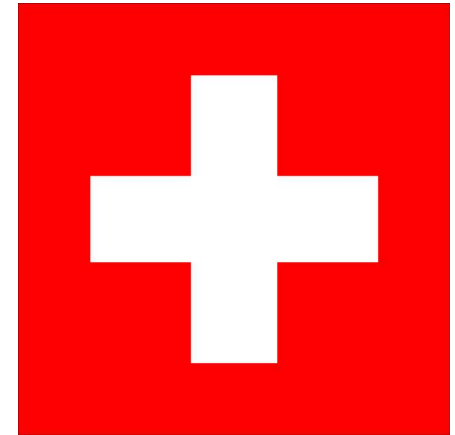

USA Company Focus

- **CA Reseller**
 - Significant CA experience, sales and services personnel.
 - Track record of successful customer sales and engagements world wide
- **CA Ecosystem Services**
 - Installation, Training, Mentoring
 - Add-on complementary products
 - WebClient for CA Plex
 - CM Connector for CA Plex
 - Matchpoint

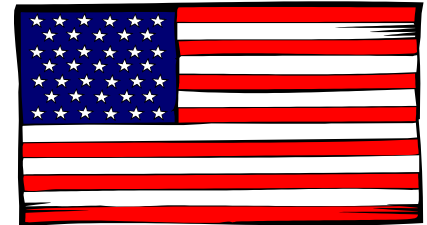

Modernization In-Place

- **Rationale**

- Enterprise assets difficult/expensive to replace
- Often fit the business well
- Expertise in place to support

- **Techniques**

- Create independent workflow user interfaces using modern BPM Software
- Create modern web interfaces using Ajax tooling, using SOA
- Upgrade staff expertise incrementally



BPM Solution



Efficient Process Enabling



- **Standard BPM software features**
 - process modeling, service development, etc.



- **Customer-focused innovations:**
 - GUI development support
 - fast prototyping
 - efficient change management

Complete Integration



- **Staff-friendly interfaces**
 - HTML
 - RIA
 - multilingual
- **Legacy-friendly system**
 - platform independent
- **End-to-end process**
 - model + design
 - execute
 - monitor + control

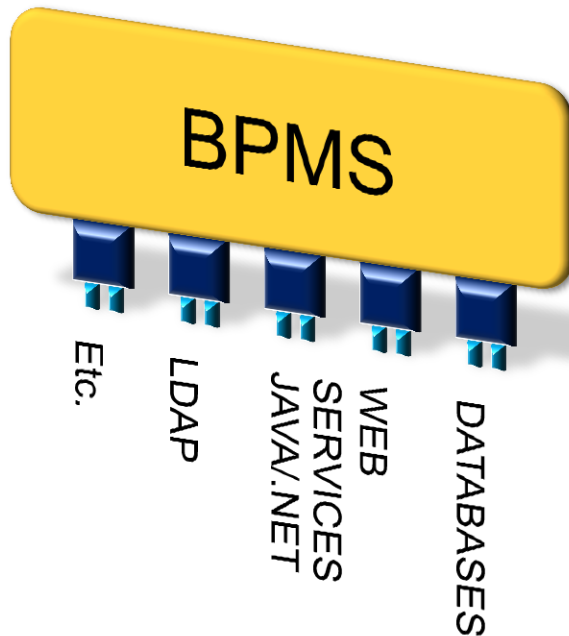

Managing Change

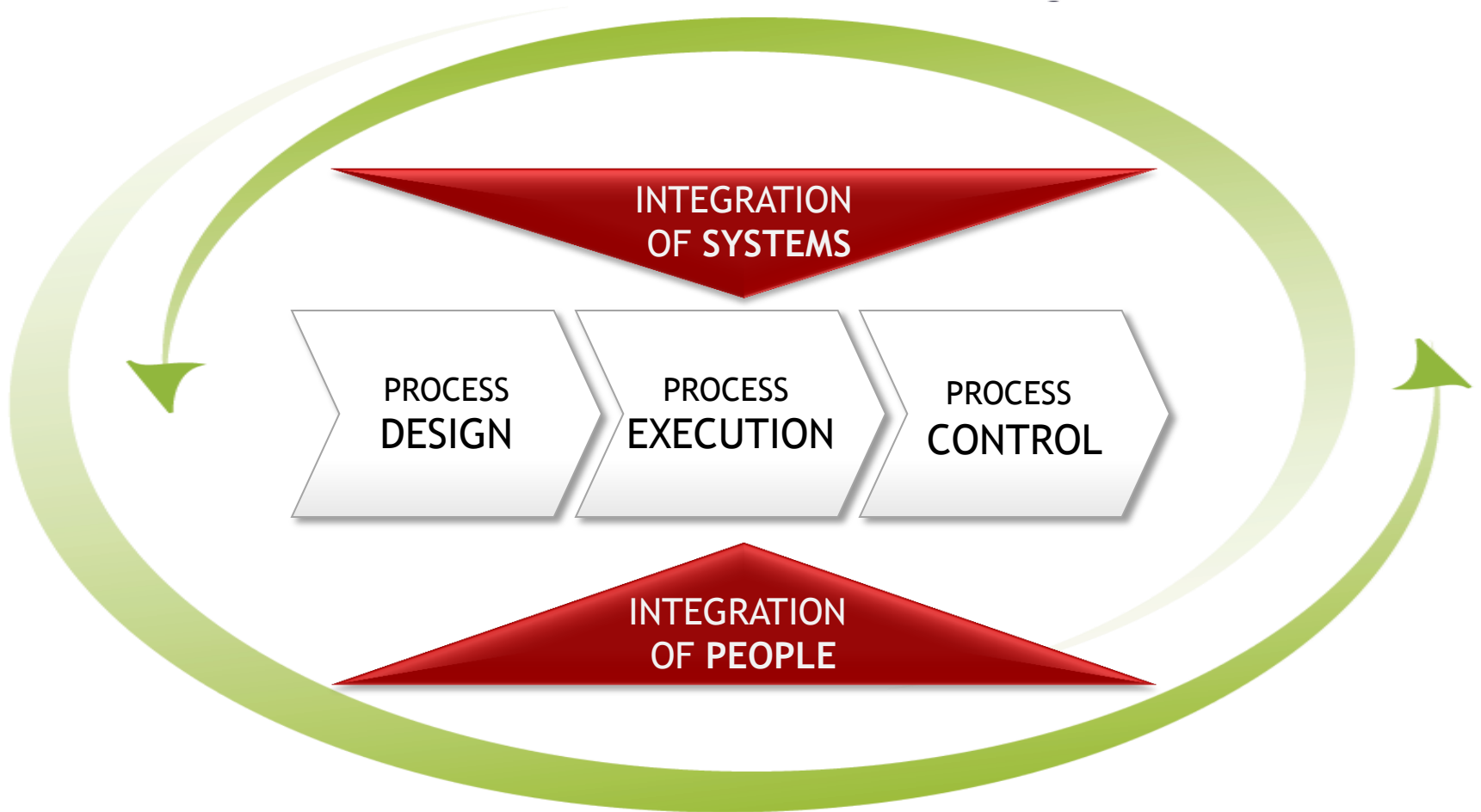

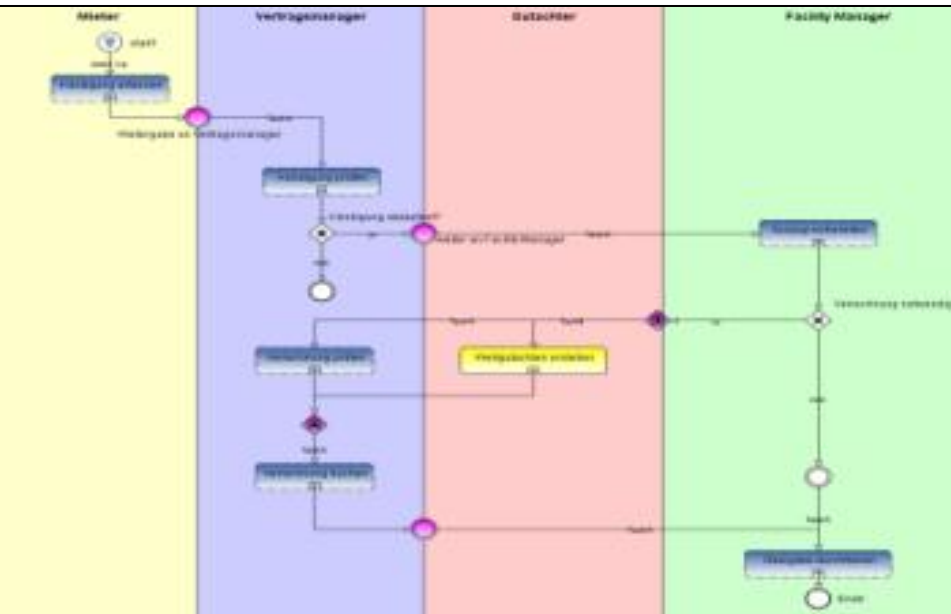

- **BPMN-Notation**
- **XPDL**
- **Animation**
- **Model-checker**



- **Business activity monitoring**
- **Business analysis reporting**



Web Solutions



WebClient

Web generator from the model

Same Plex function

Same Action

=
AJAX in 5
minutes
or less

The screenshot shows a web browser window titled 'WHSEGU1P - Edit Warehouse - - Internet Explorer provided by Dell'. The address bar shows 'http://app2.adcaustin.com/MDSwebDev/webclient'. The page content includes a navigation menu with 'Logistics', 'Process', 'Labor', 'Orders', 'Transportation', and 'Purchasing'. Below the menu is a form titled 'CORP > WHSEGU1P - Edit Warehouse -'. The form has input fields for 'Warehouse' (value 0), 'Description', and 'Available for Orders' (value Available). There is an '+ Add' button. Below the form is a table with the following data:

	Warehouse Number	Description	Available for Orders
●	1	Central Warehouse1	Available
●	2	Secondary Warehouse	Available
●	3	Freezer Warehouse	Not Available
●	4	Refrigerator Warehouse	Available
●	10	Off Site Warehouse	Available
●	18	Off Site Warehouse	Available

At the bottom of the browser window, there is a status bar with 'Done', 'Internet | Protected Mode: Off', and '100%'.

Ajax Inheritance

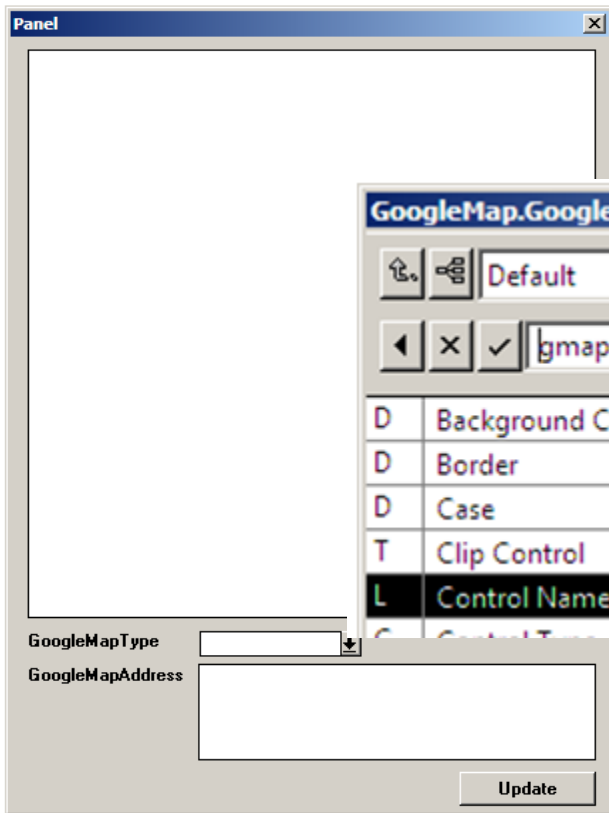

WebClient “Next Release” Roadmap

MDI, Mobile, Cloud

- MDI (Multiple Document Interface)
- Additional components
 - FileOpen, Progress, Slider, ...
- Mobile Templates
 - iPhone and Android
- Cloud Computing
 - Pre-defined on-demand instances
 - Amazon Elastic Cloud, Microsoft Azure, ...

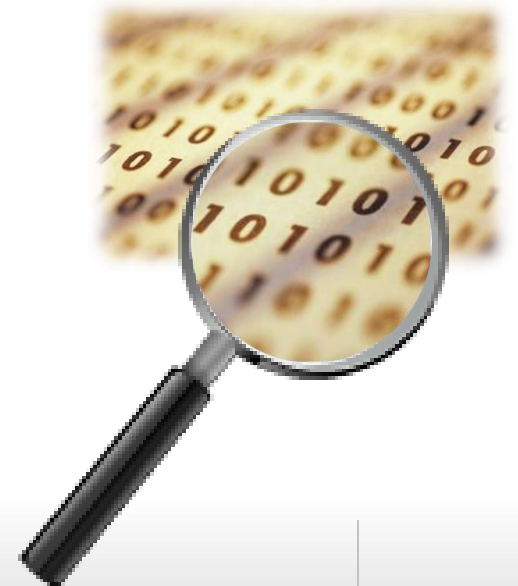

Cloud Computing Instances



Deploy pre-defined load balanced instances of CA Plex WebClient applications in Cloud environments

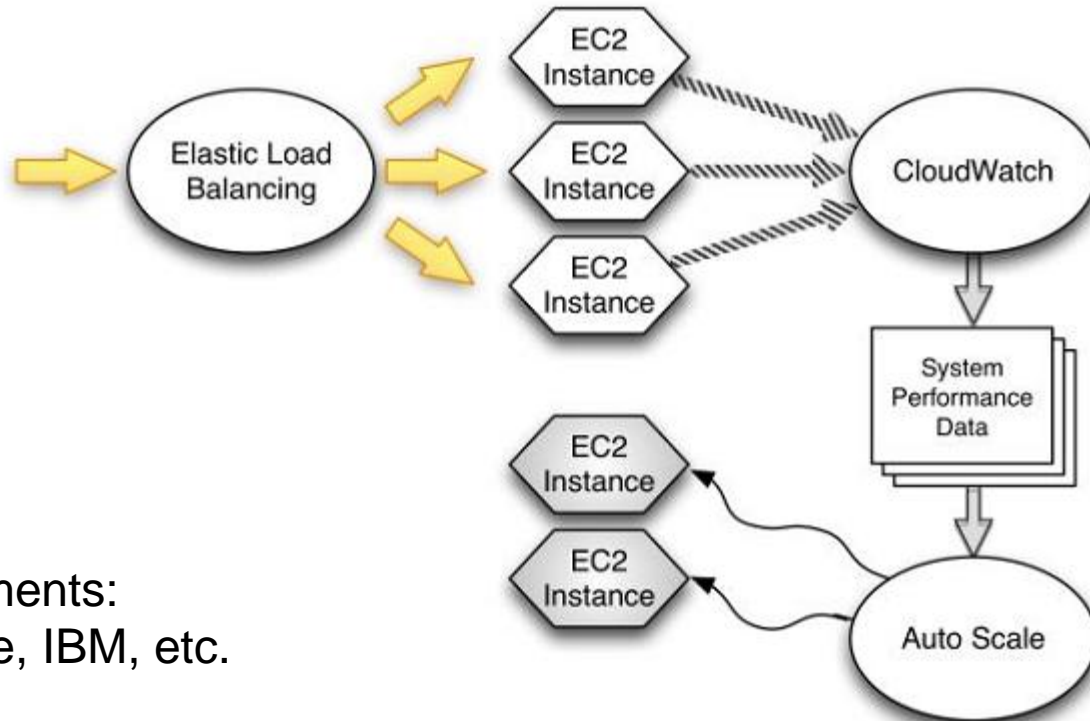

Other environments:
Windows Azure, IBM, etc.

Cloud Computing Instances

The screenshot shows the AWS Management Console interface for Amazon EC2. The navigation pane on the left includes sections for EC2 Dashboard, INSTANCES, IMAGES, and ELASTIC BLOCK STORE. The main content area is titled 'My Instances' and shows a table of instances. The table has the following data:

Name	Instance	AMI ID	Root Device	Type	Status	Security Groups
	i-b81edad5	ami-c5e40dac	ebs	t1.micro	running	default
WebClientTraining	i-fe3a9c93	ami-fe5eaa97	ebs	c1.medium	stopped	WebClient
WebClientTraining	i-f83a9c95	ami-fe5eaa97	ebs	c1.medium	stopped	WebClient
WebClientTraining	i-fa3a9c97	ami-fe5eaa97	ebs	c1.medium	stopped	WebClient
WebClientTraining	i-f42a9c99	ami-fe5eaa97	ebs	c1.medium	stopped	WebClient

Below the table, it indicates '0 EC2 Instances selected' and provides the instruction 'Select an instance above'.

Sencha Touch

Android + iOS



- Covers 93% of mobile traffic
- HTML 5, CSS3
- SaSS
- Local Storage
- Media/Geo

Thank you

The image shows a screenshot of the CMFIRST TECHNOLOGIES website. At the top left is the logo for CMFIRST TECHNOLOGIES. To the right is a search bar with the text "Site Search:" and "Google™ Custom Search" inside, and a "Search" button. Below the search bar are three buttons: "WebClient" (with a globe icon), "References and Distributors" (with a document icon), and "News and Blogs" (with a speech bubble icon). A horizontal navigation bar contains five items: "ABOUT US", "PRODUCTS & SERVICES", "EVENTS", "CUSTOMER CARE", and "CONTACT US". The main content area is divided into two columns. The left column features a large image of a computer monitor displaying a software interface, with the text "Model Bas" below it. Underneath is a blue box with the heading "OUR PRODUCTS" and "WebClient i+ Platform". Below this is a paragraph: "The WebClienti+ platform is a cutting edge shtml/Ajax generator for CA Plex. Developers use WebClient i+ to create Rich Internet Applications and SOA frameworks over their CA 2E or CA Plex models." and a link: "» Learn more about Application Modernization". The right column has a section titled "Featured Events". It lists two events: "5th CA 2E/Plex Worldwide Users Event: June 1-3, 2010" and "Next Generation BPM Summit: January 17-20, 2011". A large, semi-transparent grey rounded rectangle is overlaid in the center of the page, containing the text "CMFIRSTTECH.COM" and "JDRHODES@CMFIRSTTECH.COM" in white.

cmFIRST TECHNOLOGIES

Site Search: Search

WebClient References and Distributors News and Blogs

ABOUT US PRODUCTS & SERVICES EVENTS CUSTOMER CARE CONTACT US

Model Bas

OUR PRODUCTS
WebClient i+ Platform

The WebClienti+ platform is a cutting edge shtml/Ajax generator for CA Plex. Developers use WebClient i+ to create Rich Internet Applications and SOA frameworks over their CA 2E or CA Plex models.

» Learn more about Application Modernization

Featured Events

5th CA 2E/Plex Worldwide Users Event: June 1-3, 2010

Next Generation BPM Summit: January 17-20, 2011

Learn More

CMFIRSTTECH.COM
JDRHODES@CMFIRSTTECH.COM